

# User Manual & Installation Guide

## Model: Hafele HORIZON

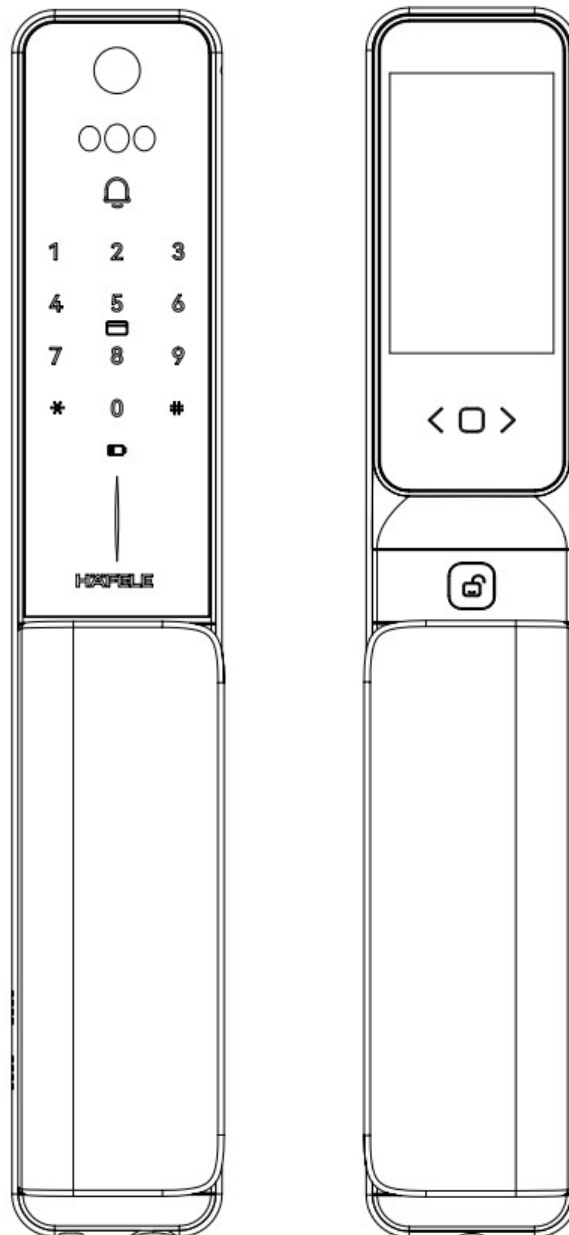

Disclaimer: The contents of this user manual are subject to change without prior notice to the user in order to enhance performance of the product.

## Table of Contents

---

<b>1 Read before use</b>	<b>Page</b>
1.1 Warnings	4
1.2 Product specifications	4
1.3 Additional features	5
1.4 Product overview	6

<b>2 Installation guide</b>	<b>Page</b>
2.1 Components	7
2.2 Screw size matrix	8
2.3 Installation steps	9-11

<b>3 Settings</b>	<b>Page</b>
3.1 Local menu table	12
3.2 Demo mode	13
3.3 First time setting	13
3.4 Add normal users	14
3.5 Delete all normal users	15
3.6 Add-on settings (Optional)	15
3.7 Network Settings	16-17
3.8 Voice Settings	17

## Table of Contents

---

<b>4 Lock operation</b>	<b>Page</b>
4.1 Outdoor unit description	18
4.2 Indicator lights	18
4.3 Indoor unit description	19
4.4 How to lock & unlock the door	19
4.5 Privacy mode	20
4.6 Passage mode	20
4.7 Wi-Fi APP requirements	21
4.8 Hafele Smart Living APP	21
4.9 How to use the smartphone APP	22-25
4.10 Li-ion Battery System	26
4.11 Digital door viewer	27-28













<b>5 Service features</b>	<b>Page</b>
5.1 Emergency power supply	29
5.2 Battery replacement instructions	29
5.3 Restore factory settings	30
5.4 Troubleshooting guide	30

## 1. Read before use

### 1.1 Warnings

1. Read and understand all instructions before use.
2. Do not expose the product and accessories to rain or direct sunlight.
3. When cleaning the product, please wipe it with a soft cloth.
4. Do not scrape the fingerprint sensor with any sharp objects.
5. If damage is caused by failure to follow this instructions, the warranty does not apply.
6. Do not expose the product to corrosive substances to avoid damage.
7. Please make sure the battery is fully charged before use. If a low battery warning appears, please remove the battery and charge it immediately.
8. If the lock is not in use for a long time, please take out the battery to maintain its efficiency and extend its lifespan.





### 1.2 Product specifications







Features	
	Face ID
	Fingerprint
	Key card
	Password
	Mechanical Key
	Video Door Phone
	Wi-Fi APP
	Door Viewer
	Li-ion Battery System
	Handle Lighting
	English Voice Prompts
	USB-C Emergency Power

Basic Specification		
<b>User Capacity</b>	<ul style="list-style-type: none"> <li>• Administrator ID (with Fingerprint, Key card and Password)</li> <li>• 400 Users with combinations of Face ID, Fingerprint, Key card or Password.</li> <li>• 30 APP Custom passcodes</li> </ul>	
<b>6 unlocking ways</b>	Face ID, Fingerprint, Password, Key card, Mechanical Key and Smartphone APP	
<b>Voice guide language</b>	English, male or female voice	
<b>Power Supply</b>	Li-ion Battery	Main 5000 mAh Li-ion
	Emergency Power	5V, Type-C USB interface
	Operating Voltage	> 4.8V
<b>Material</b>	Lock panels	Aluminium alloy, Tempered glass
	Mortise lock	Stainless steel
<b>Working environment</b>	Temperature	-20 to +70 Degree Celsius
	Humidity	40%-80%
	Ingress protection	Outdoor unit: IP65 Indoor unit: IP53

## 1. Read before use

### 1.3 Additional features

<b>Locking Modes</b>	
	<p><b>Auto Locking Mode</b> When the door is closed the bolt will lock automatically.</p>
	<p><b>Passage Mode (Remain unlocked)</b> After activation the door is unlocked for everybody.</p>
	<p><b>Privacy Locking Mode</b> When activated from the inside, only local administrators and the mechanical key can open the door from outside.</p>
	<p><b>Double Authentication Mode</b> In this high security mode, users need to enter a combination of 2 access credentials to open the door.</p>

<b>Security &amp; Alarms</b>	
	<p><b>Random Passcode</b> Random digits can be added before or after the passcode to hide your real code from other persons.</p>
	<p><b>Panic Exit</b> It is always possible to unlock from the inside with a mechanical lever latch.</p>
	<p><b>System Lockout</b> After 6 wrong attempts to unlock, the system enter a lockout mode for 90 seconds and sound an alarm.</p>
	<p><b>Burglar Alarm</b> If the lock detects any mechanical manipulations it will sound an alarm for 120 seconds.</p>
	<p><b>Door Ajar Alarm</b> If the door isn't completely closed and the bolts are unable to auto-lock, a reminder alarm will sound.</p>
	<p><b>Low Battery Alarm</b> The lock will remind you to charge the battery with the light indicator and a voice prompt.</p>

## 1. Read before use

### 1.4 Product Overview

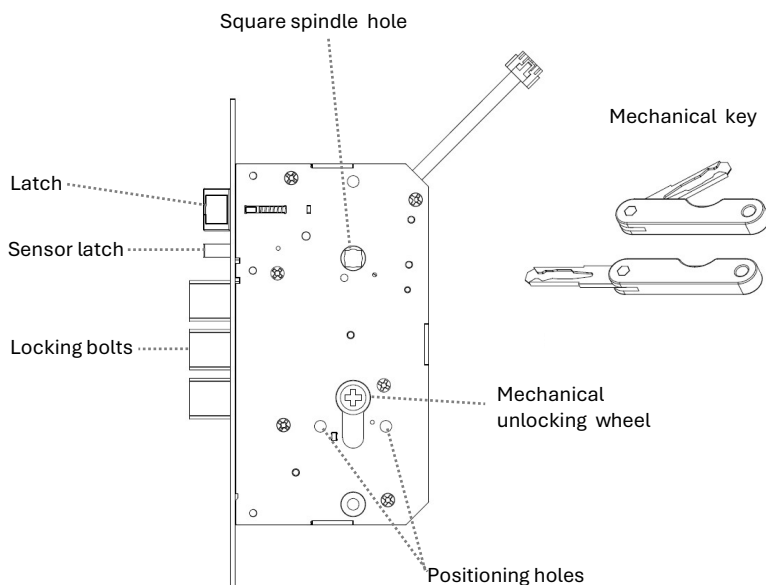
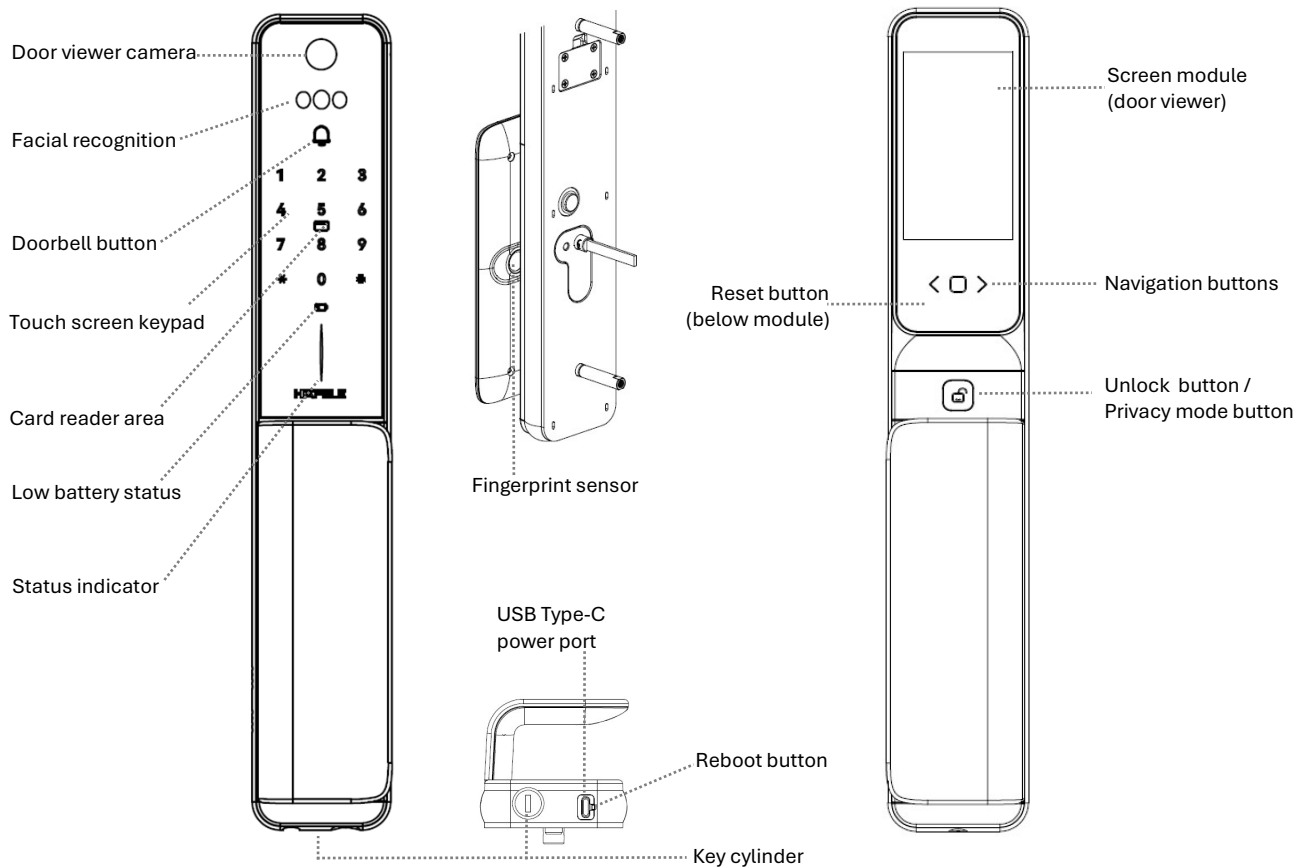

Packing List	
Outdoor unit	1 pc
Indoor unit	1 pc
Mortise lock pack	1 set
Accessories pack	1 set
Mechanical keys	2 pcs
Battery	1 pc
Drilling template	1 pc
Quick start guide	1 pc

## 2. Installation guide

### 2.1 Components

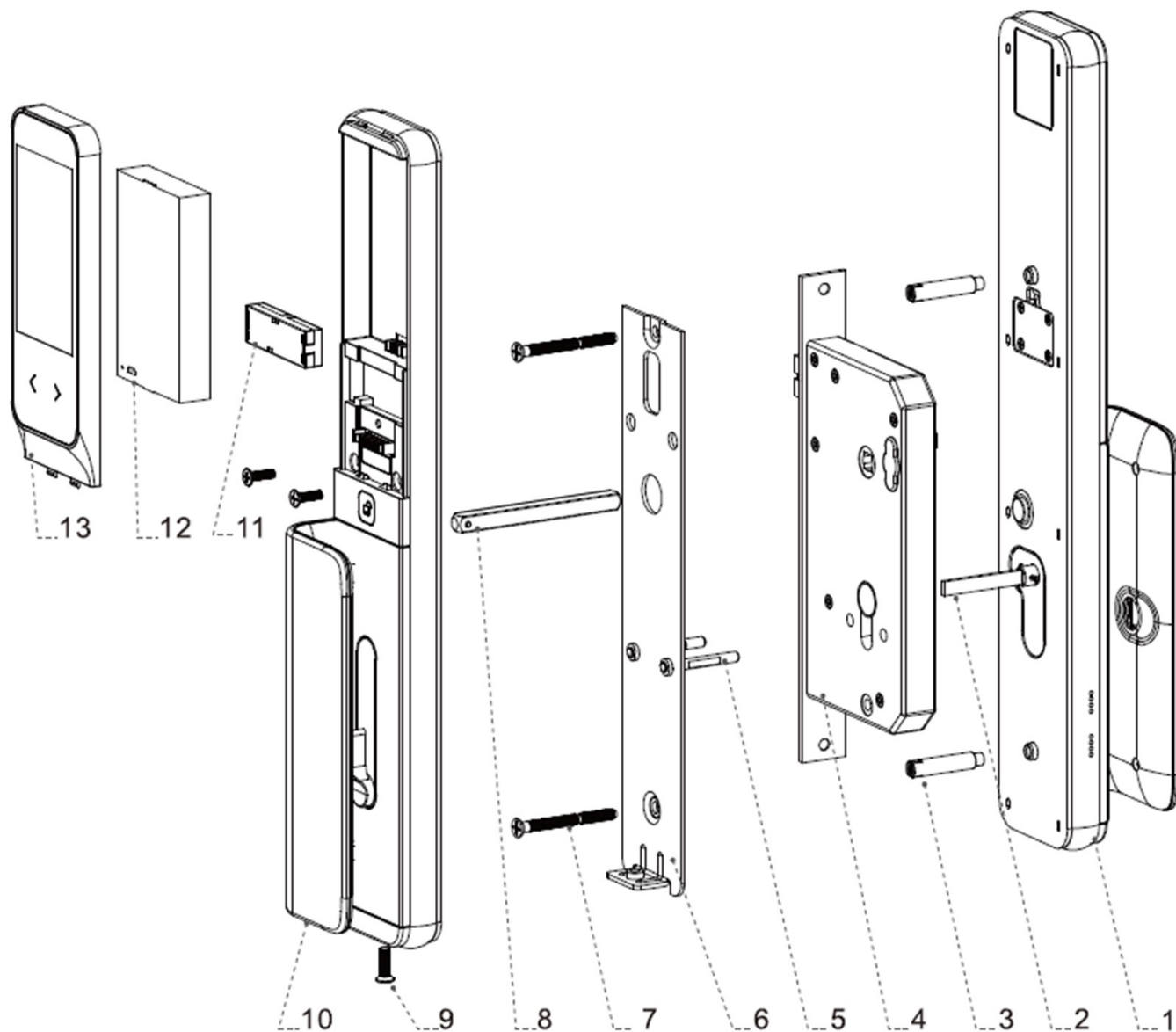

1. Outdoor unit

6. Mounting plate

11. Plug-in module (option)

2. Transmission rod

7. Screws

12. Battery Pack

3. Stud

8. Square spindle

13. Screen module

4. Mortise lock

9. Back panel fixing screws

5. Positioning screw

10. Indoor unit

## 2. Installation guide

### 2.2 Screw size matrix

#### Infinity / Horizon Installation Accessories Instruction

Door Thickness	M5 Screw	Positioning Screw 2pcs	Transmission Rod	Square Spindle
≥33mm <40mm	M5x18mm 2pcs	Cut 4 segments	Cut 4 segments	8x8x32mm
≥40mm <45mm	M5x95mm 2pcs - cut 5	Cut 3 segments	Cut 3 segments	8x8x45mm
≥45mm <65mm	M5x95mm 2pcs - cut 4-5	Cut 2-3 segments	Cut 2-3 segments	8x8x45mm
≥65mm <95mm	M5x95mm 2pcs - cut 1-3	Cut 1-2 segments	Cut 1-2 segments	8x8x65mm
≥95mm <110mm	M5x95mm 2pcs - no cut	No Cut	No Cut	8x8x65mm

M5 Screw

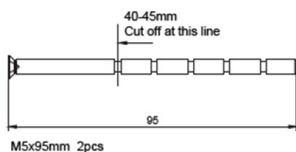
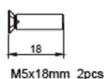

Positioning Screw 2pcs

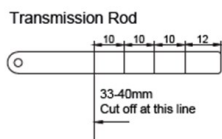
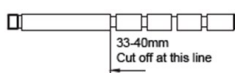

Square Spindle

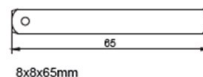
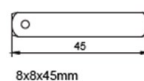
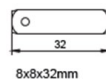

Lock pin



M5 Stud 2pcs

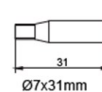

Hex key 3mm



## 2. Installation guide

### 2.3 Installation steps

**1** Draw lines on the door as marked on the drilling template, the suggested distance between the lock and the floor is 1m - 1.1m. Then drill the holes as required.

**2** Insert the mortise lock into the door and use two pieces of self tapping screws (from mortise lock pack) to fix it in place.

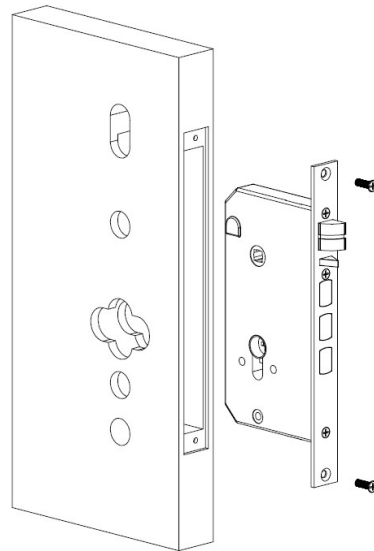
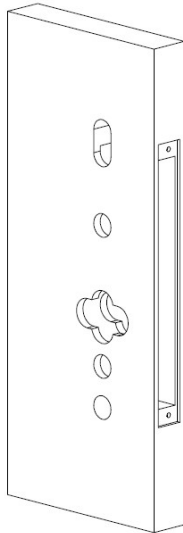

**3 Confirm the handle direction:**  
Ensure that the inner and outer grip positions are opposite to the visible face of the mortise lock. This step prevents the door frame from hitting the handle grip when closing the door. (If the grip positions are the same, adjust the handle direction as shown in the diagram.)

Steps to adjust the handle direction

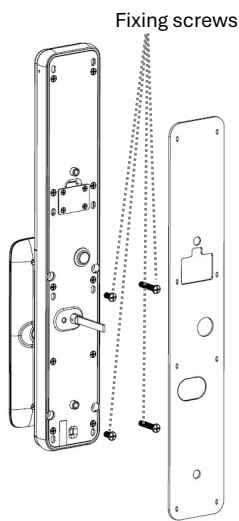

**A:** Detach the silicone pad from the handle assembly and remove four fixing screws.

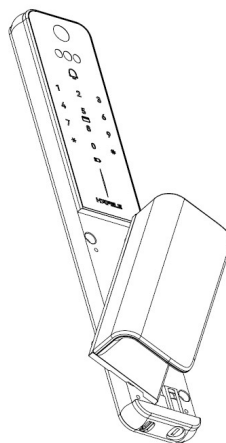

**B:** Rotate the handle to the desired direction

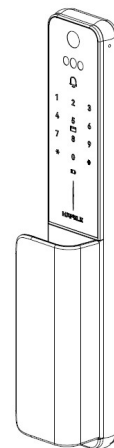

**C:** Reattach the handle by tightening the four fixing screws to lock it.

## 2. Installation guide

### 2.3 Installation steps

- 4** Install two studs into the outdoor unit. Adjust the length of the transmission rod as per the screws size matrix on page 8. Then use a lock pin to fix it in place.

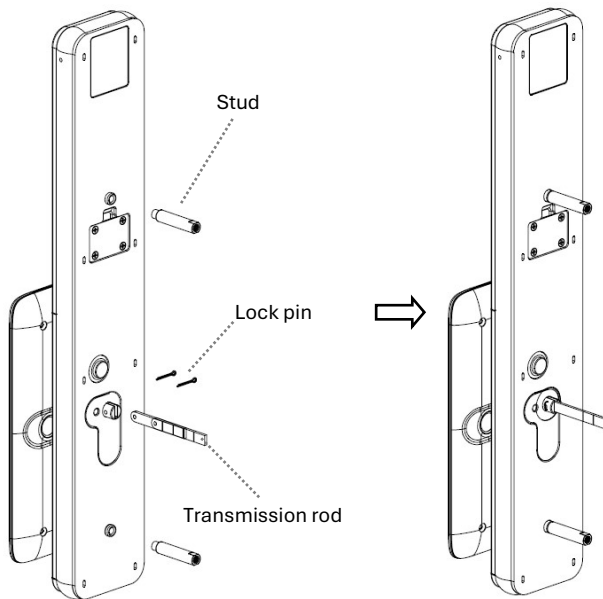

- 5** Adjust the lengths of the 2 positioning screws as per the screws size matrix on page 8. Install the screws in the mounting plate.

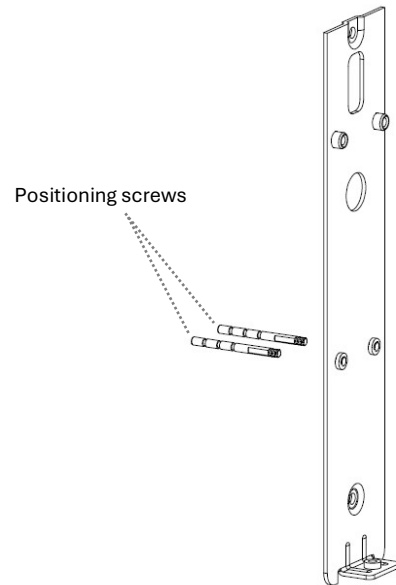

- 6** To install the outdoor unit, pass three cables through the large hole in the door. Make sure the transmission rod aligns with mechanic unlocking wheel of the mortise lock. Then use the screws to fix the outdoor unit to the lock mounting plate.

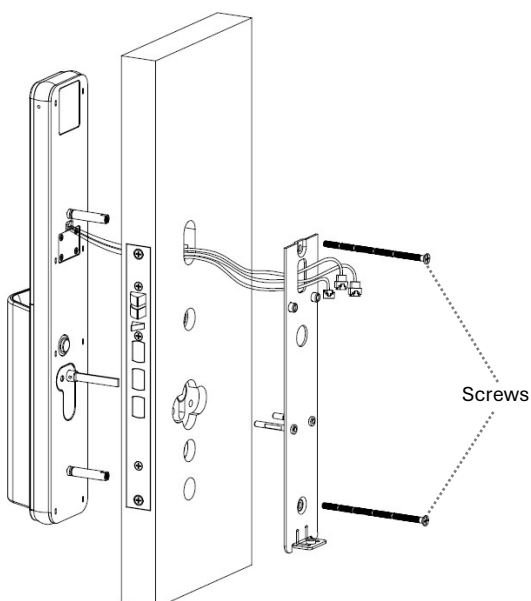

- 7** Align the square spindle pin to the handle base on the indoor unit. Push the pin in and slide the spindle in place until it locks securely. Connect the cables from the outdoor unit to the matching connectors.

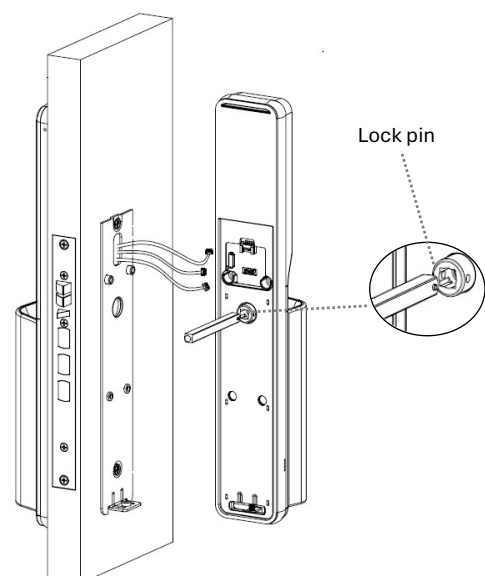

## 2. Installation guide

### 2.3 Installation steps

- 8 Align the square spindle and insert the indoor unit on the mounting plate. Then use three fixing screws to secure the unit to the plate. Check the proper operation of the mechanical lever latch.

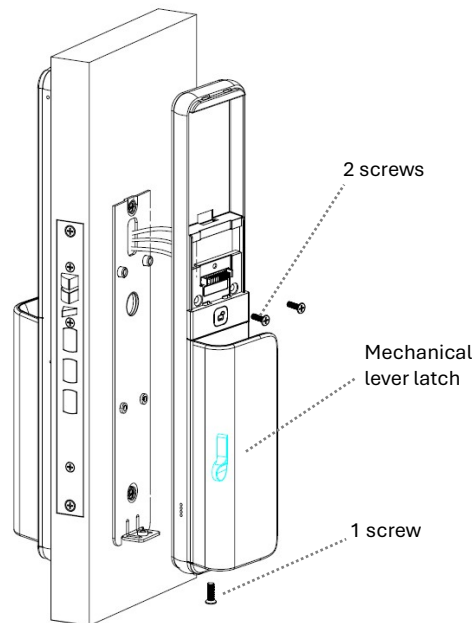

- 9 Insert the battery pack into battery compartment and Install the screen module by attaching it and then slide it downwards into place.

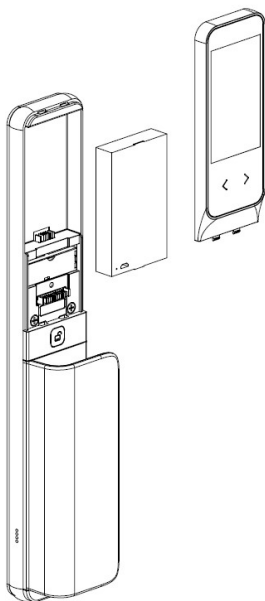

**i** Note: The installation is now finished. After inserting the battery, the lock should power on. Please proceed with lock settings.

**!** Caution: After first start-up the lock is in **Demo Mode**. Any Face ID, fingerprint, key card or password can open the door.

## 3. Settings

### 3.1 Local menu table

**i** Note: Double click [\*] to enter the settings mode. The factory default administrator password is 123456.

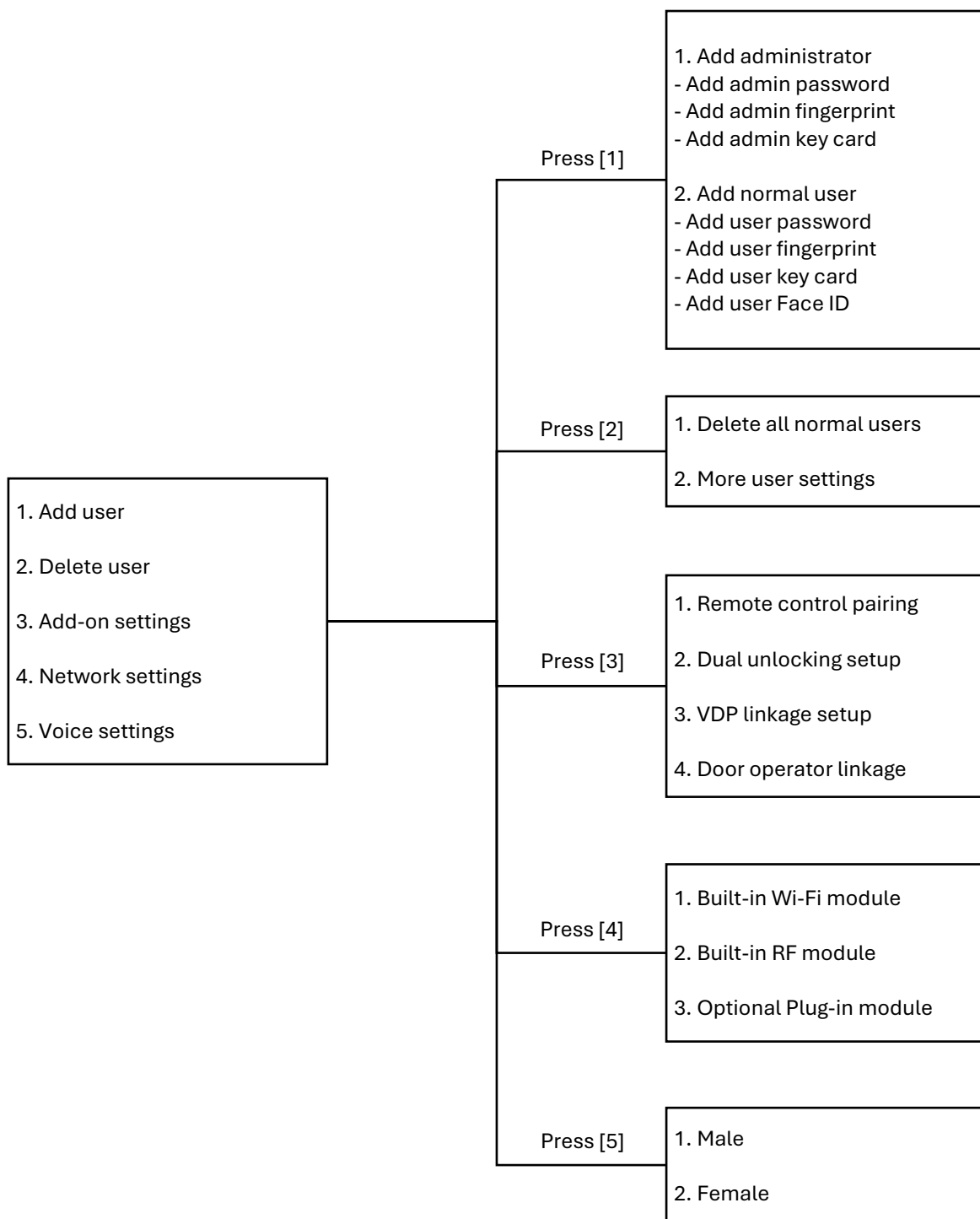

## 3. Settings

### 3.2 Demo Mode

Demo mode (First use or after reset to factory settings)

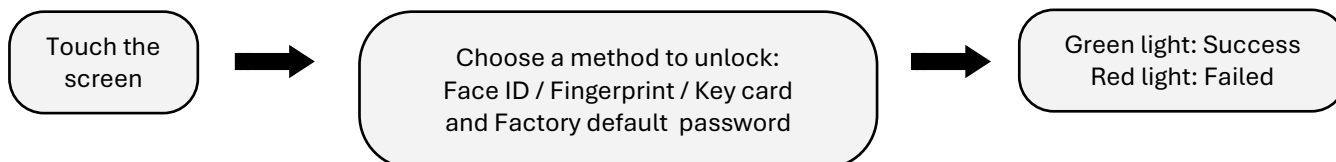

**⚠ Caution:** Any Face ID, fingerprint, key card or password can open the door.

### 3.3 First time setting

Add an administrator (Lock owner)

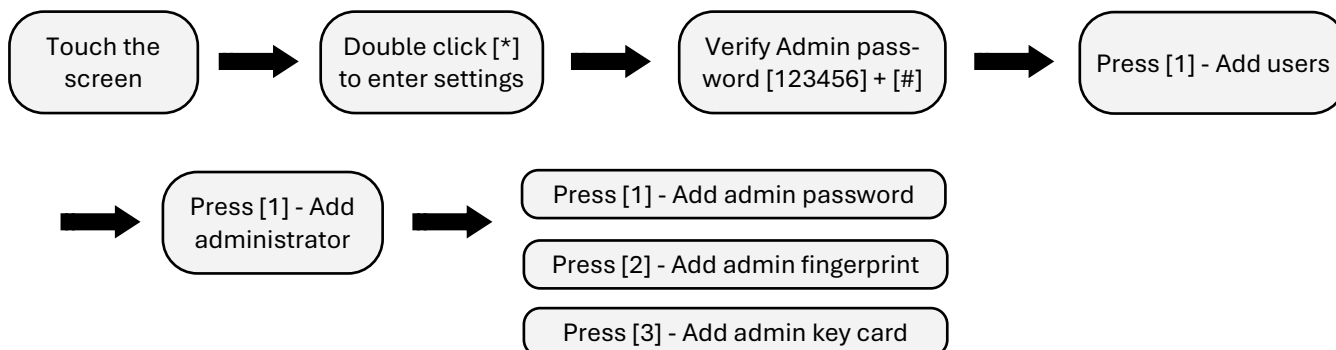

**⚠ Caution:**

- You have to register an admin user first, then proceed with the other lock settings.
- When you do the first registration, the default admin password is 123456.
- Make sure your fingers are clean and dry before using the fingerprint reader. Dirt, oil and moisture can interfere with the recognition.

### 3. Settings

#### 3.4 Add normal users (Register admin user before doing this step)

**i** Note: Only add users locally if no Wi-Fi network is available to pair your lock with the Hafele Smart Living APP. It is recommended to use the smartphone APP to manage users and lock settings.

Note: Locally added users will appear in the smartphone APP, but need to be manually assigned to an APP user.

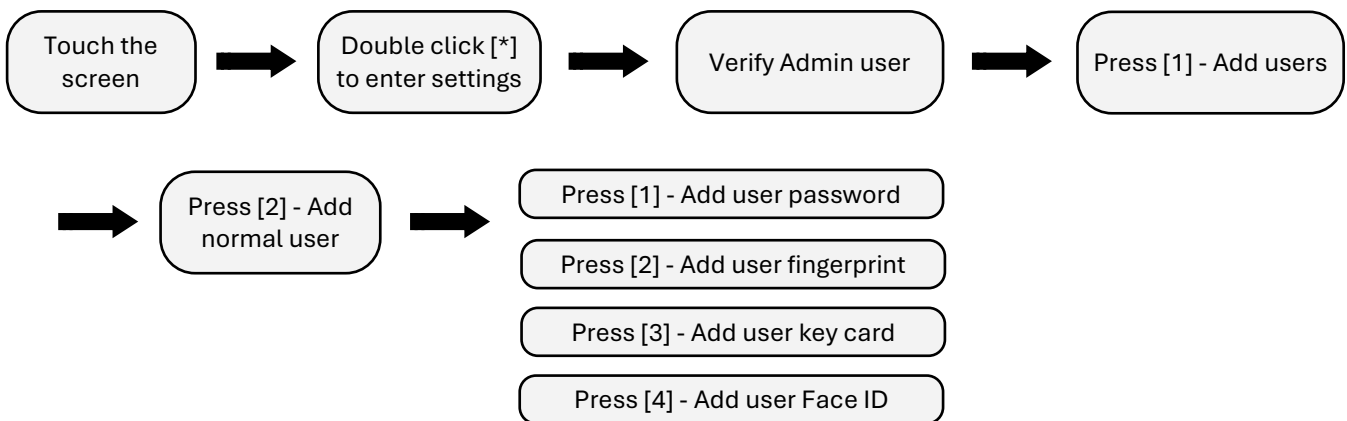

Note: Face ID; Please follow the instructions:

1. Please stand at an appropriate distance and face the camera (0.3m - 1m).
2. Follow the voice prompt to add face ID:
  - Turn your face to the left side.
  - Turn your face to the right side.
  - Turn your face down.
  - Turn your face up.
3. If the registration fails, please try again following the same steps.

## 3. Settings

### 3.5 Delete all normal users

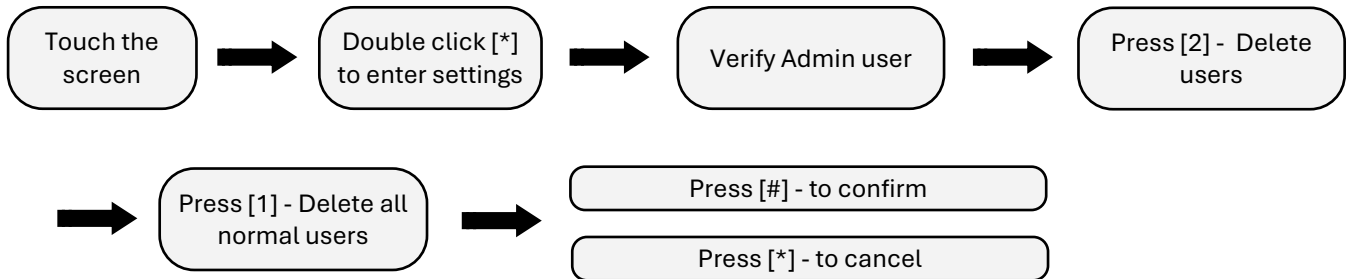

**Caution:**

- This action will delete all users added locally or by the smartphone APP at once! For individual deletion of the user data, please use the smartphone APP.
- The Admin user will not be deleted, only a restore to the factory settings can delete the admin user.

### 3.6 Add-on settings



**Note:** This function is designated for Hafele wireless communication accessories for additional lock options. Please contact your local Hafele customer service for more information.



**Caution:** They might not be available in all countries and require specialist knowledge to be installed. For further information, please contact your local Hafele offices.

## 3. Settings

### 3.7 Network settings

**i** Note: As the factory default setting, all wireless communication modules of the lock are disabled. In order to connect to the Hafele Smart Living APP or a RF remote control, they need to be enabled first.

#### A. Built-in Wi-Fi module setting / Smartphone APP Pairing

- !** Caution:
- Ensure the back panel screen is installed before proceeding with this setting (The Wi-Fi module is located inside).
  - The Hafele Smart Living APP pairing only supports the 2.4 GHz Wi-Fi band. Make sure it is enabled on your local Wi-Fi Access Point.

1. Download the "Hafele Smart Living" application from Apple Store or Google Play



2. Sign up App's account by email or log in if you already have an account.
3. Enable your smartphone's Bluetooth and connect to the Wi-Fi network you want to connect your lock.
4. Enable lock pairing mode:

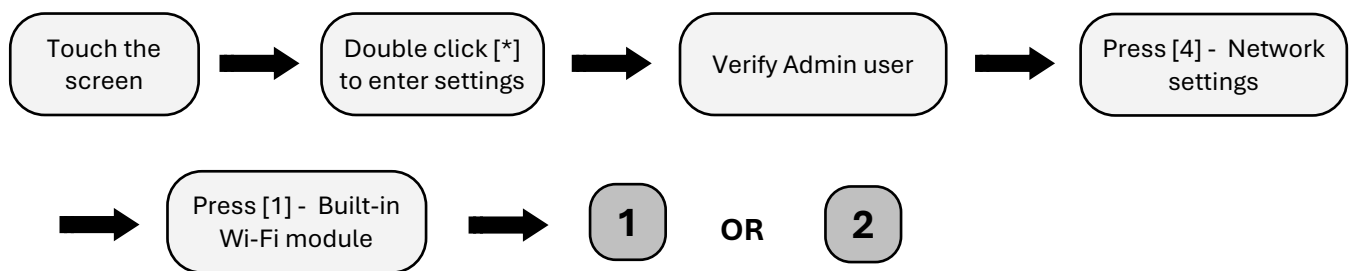

**1** Enable Wi-Fi and start APP pairing process.

**2** Disable Wi-Fi and delete APP pairing.

5. Click "Add device" in the top right corner of the APP, the next screen will show any available lock on the top with an "Add" icon.
6. Click "Add" to start the process, then click "Done" to finish the pairing process.
7. You can now manage users and lock settings with your smartphone APP.

## 3. Settings

### 3.7 Network settings

#### B. Built-in RF module setting

**i** Note: This function is designated for Hafele wireless communication accessories for additional lock options. Please contact your local Hafele customer service for more information.

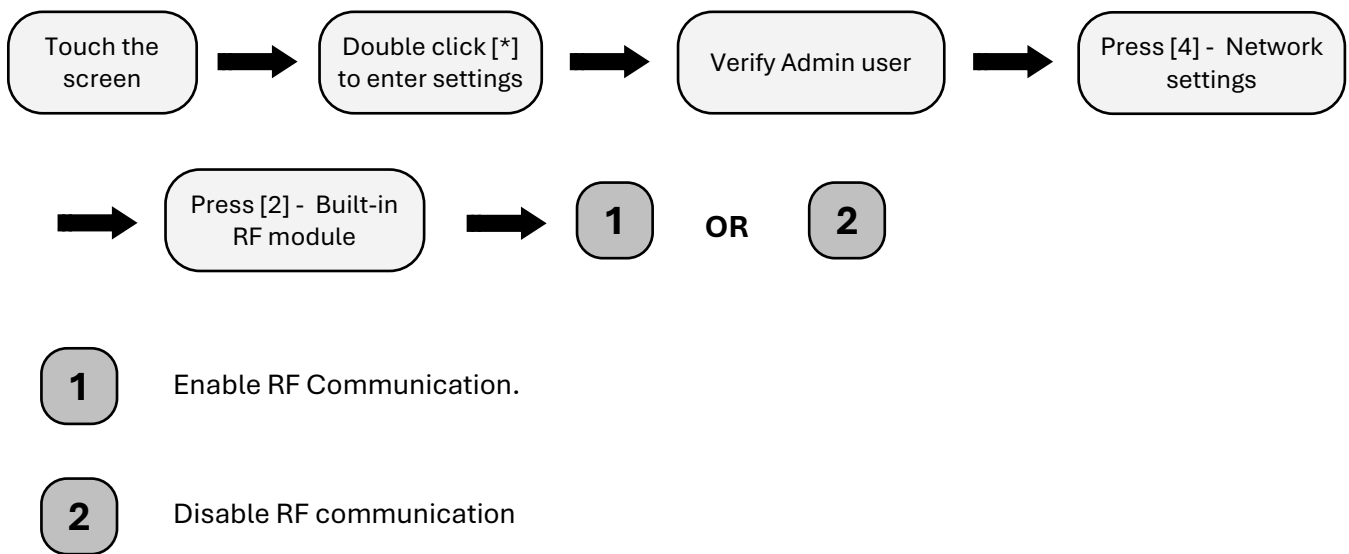

#### C. Optional plug-in module settings

**i** Note: This function is designated for an IO module expansion to 3rd party systems. It is not used for standard applications and only prepared for customized projects in the future.

### 3.8 Voice Settings

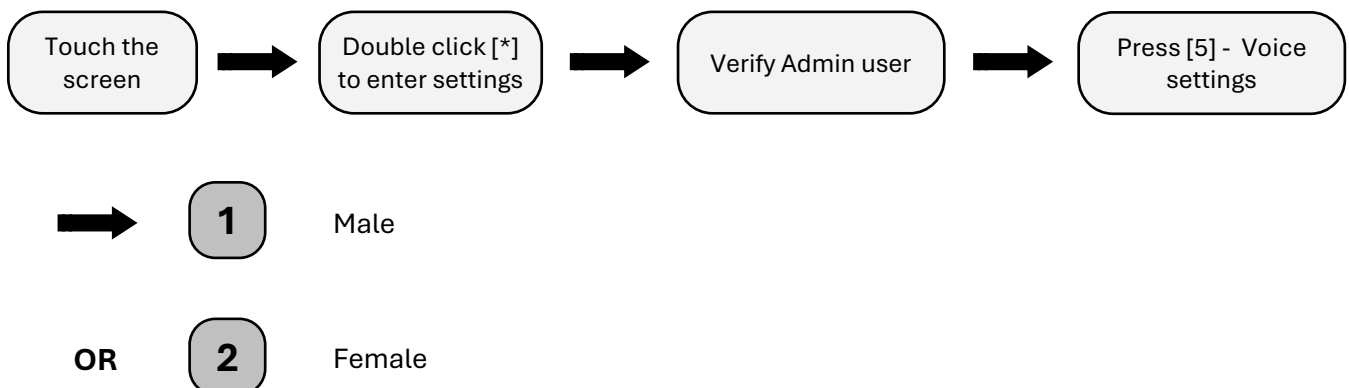

## 4. Lock operation

### 4.1 Outdoor unit description

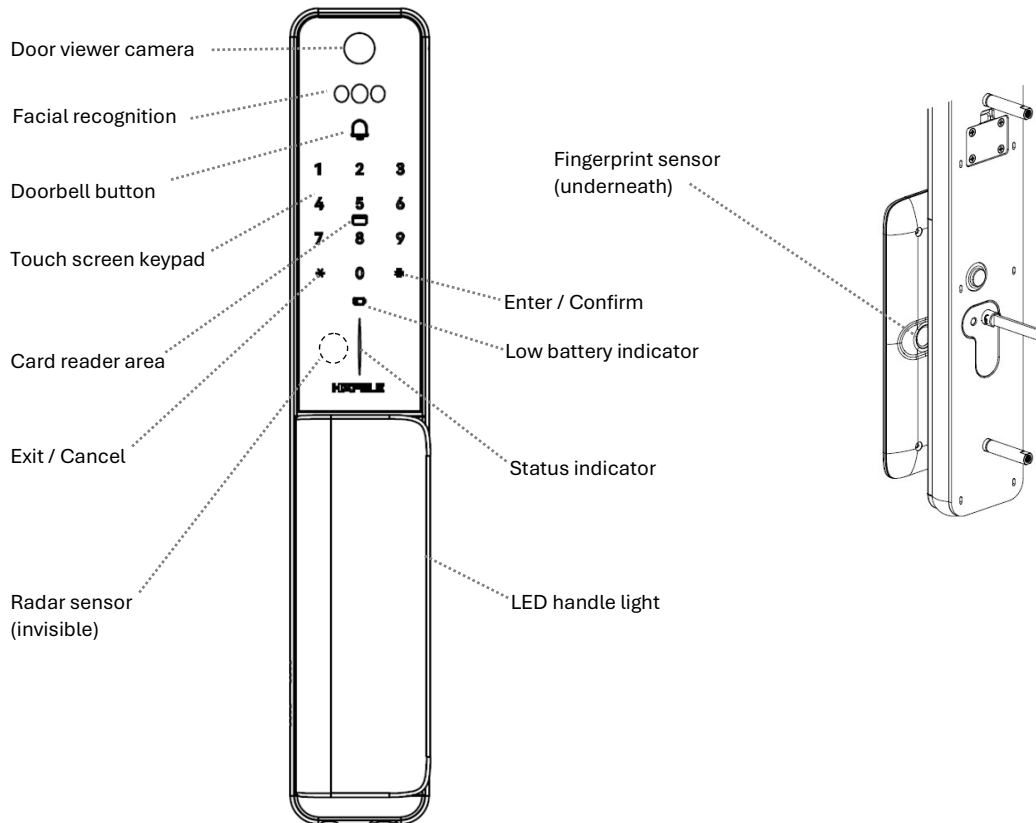

### 4.2 Indicator Lights

#### Status indicator

The indicator light will flash blue when the lock is activated, green if authentication is successful and red when authentication failed.

#### Low battery indicator

When battery is too low, the indicator light will flash red with voice prompts (Mute mode is excepted).

#### System locked indicator

If enter wrong user ID for 6 times, the lock will suspend for 90 seconds with an alarm and the status indicator light turns solid red.

#### LED handle lighting

When the lock wakes-up, the inner handle is illuminated with a welcome light to guide your hand.

#### Radar sensor

Invisible from the outside, this sensor may be enabled for face recognition or the automatic person detection in the smartphone APP.

## 4. Lock operation

### 4.3 Indoor unit description

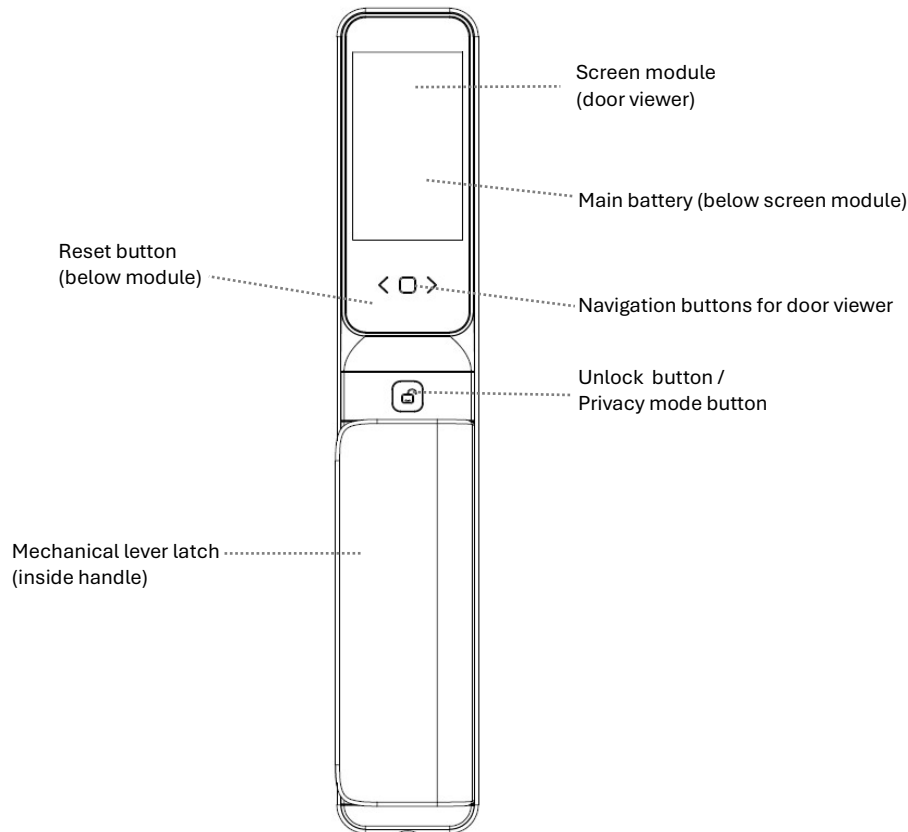

### 4.4 How to lock & unlock the door

#### 1. Locking the door

- a.) The door will lock automatically 6 seconds after closing (auto mode).

#### 2. Unlock from outside

- a.) Facial recognition: Touch the keypad to activate the lock and the facial recognition sensor.  
 Note: If the radar detection sensor is enabled, the lock will automatically wake-up and start the facial recognition process.
- b.) Fingerprint: Place the registered finger on the fingerprint sensor area.
- c.) Key card: Place the registered key card on the card reader area in front of the keypad.
- d.) Password: Touch the keypad to wake-up the lock and input an 6-8 digits password, then press the [#] button to confirm.
- e.) Mechanical Key: Insert the mechanical key and rotate to open the lock.

#### 3. Unlock from inside

- Short press the unlock button located on the indoor unit.
- Use the mechanical lever latch to manually unlock.

## 4. Lock operation

---

### 4.5 Privacy mode



Caution: The privacy mode is designed to temporarily block all normal and APP users to open the door. If switched on, only the local administrator or a mechanical key can unlock from outside.

**Enable:**

Wait for the lock to automatically lock the door. Then long press the unlock button on the indoor unit for 5 seconds until you hear a voice prompt "Privacy Mode On". As a reminder, the unlock button will now flash red every 10s.

**Disable:**

To cancel the privacy mode, just short press the unlock button and wait for the auto-relock.



Note: When someone tries to unlock from outside, there is a voice prompt "Privacy mode ON".

### 4.6 Passage mode (Remain unlocked mode)



Caution: When the lock is in passage mode, the deadbolts will not engage after the door is closed. The door remains unlocked.

**Enable:**

Enable : Verify any registered user to unlock the door, all keypad lights are on for 6 seconds, then long press "6" on the keypad for 3 seconds to enable the passage mode.

**Disable:**

Unlock the door by any credentials, only number "6" will light on, then long press this number for 3 seconds to disable the passage mode.



Note: When someone tries to unlock, there is a voice prompt "Passage mode ON".

> In passage mode : To open the door, any unregistered verification data can unlock it.

> In auto locking mode: To open the door, only registered verification data can unlock it.

## 4. Lock operation

### 4.7 Important Information - Wi-Fi APP requirements

#### Thank you for purchasing a Hafele Digital Door Lock.

For full functionality, this lock is designed to use an INTERNET connection via your **local 2.4Ghz Wi-Fi** network. Many features are only available by using the smartphone APP "Hafele Smart Living".

> For pairing setup instructions please refer to page 16.

 **Caution:** For the best user experience with video calling, it is very important to ensure that the lock receives a **strong 2.4Ghz Wi-Fi signal** from the nearest wireless access point (Wi-Fi Routers or Range Extenders) and an INTERNET connection speed of minimum 50Mbps up/down.

### 4.8 Hafele Smart Living APP

#### Hafele Smart Living APP features



##### Video Door Phone

With a good Wi-Fi and internet connection, you can see and communicate with persons in front of the door from anywhere. If a visitor presses the Doorbell button, you automatically receive an incoming call notification on your smartphone.

##### Person Detection

If the Radar Detection sensor is switched ON (enable in Settings), the lock will automatically send you pictures via the smartphone APP, when a person remains in front of your door for a while.

##### APP Remote unlock

The smartphone APP allows you to unlock your door from anywhere. You may also share this permission to other APP users in the family. Note: The lock needs to be in Wi-Fi Active mode, details on page 22.

##### Member Management

You can fully manage all Family and other Members access credentials. The smartphone APP allows you to add/delete users Face ID, Fingerprints, Key Cards and Passwords.

##### Temporary Passcodes

You can create Custom Passwords with limited time plans while the lock is active from anywhere. Additionally the APP offers also offer a password generator for offline use. This is useful if you allow someone temporary access to your door.

 **Caution:** Extensive use of APP and Video features or leaving your lock in active mode for too long, will reduce the battery life.

## 4. Lock operation

### 4.9 How to use the Smartphone APP

#### 1. Main Screen

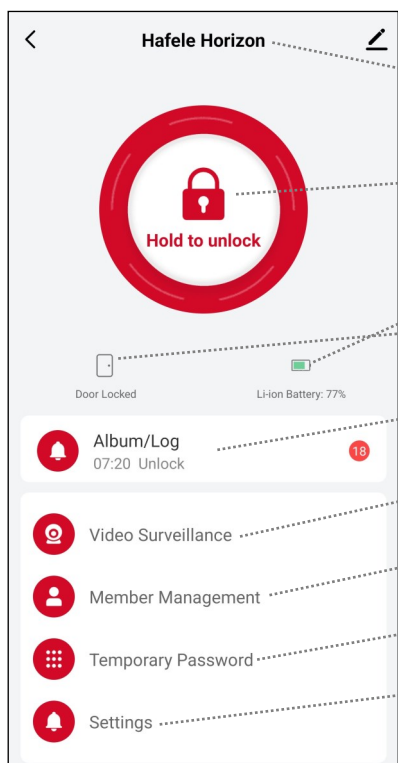

- 1. Lock name - click to change
- 2. APP Unlock Button
- 3. Li-ion Battery Status - click icon for details
- 4. Door Status
- 5. Picture album , Door opening and Alarm records
- 6. Video Door Phone
- 7. User management
- 8. Temporary Passcode management
- 9. Lock Settings

#### 2. Settings (part 1)

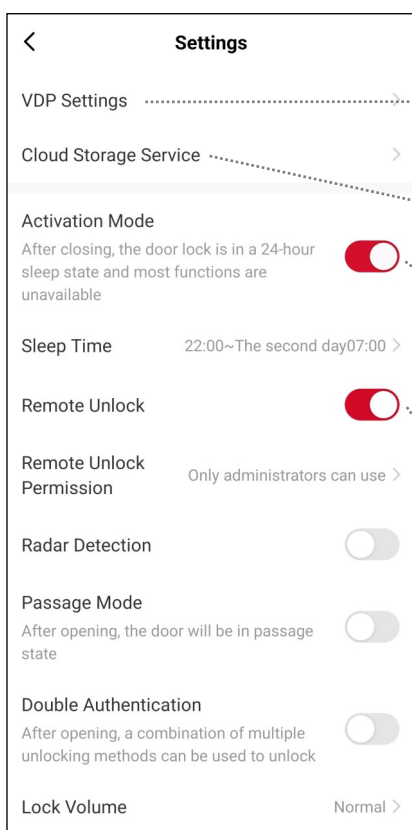

- 1. **Video Door Phone Settings**  
Select two- or one-way communication for video calls.
- 2. **Cloud Storage service**  
Optional paid subscription service to extend video and picture storage period. No subscription only allows pictures storage for 14 days.
- 3. **Activation Mode**  
By default the lock is in sleep mode and activates only during wake-up. If it is required to the lock always on-line, activate this switch. Additionally a night-time sleep period can be specified. These settings greatly affect the battery life time.
- 4. **Remote APP Unlock Permission**  
App unlock can be disabled or limited to administrators only.

## 4. Lock operation

### 4.9 How to use the Smartphone APP

#### 2. Settings (part 2)

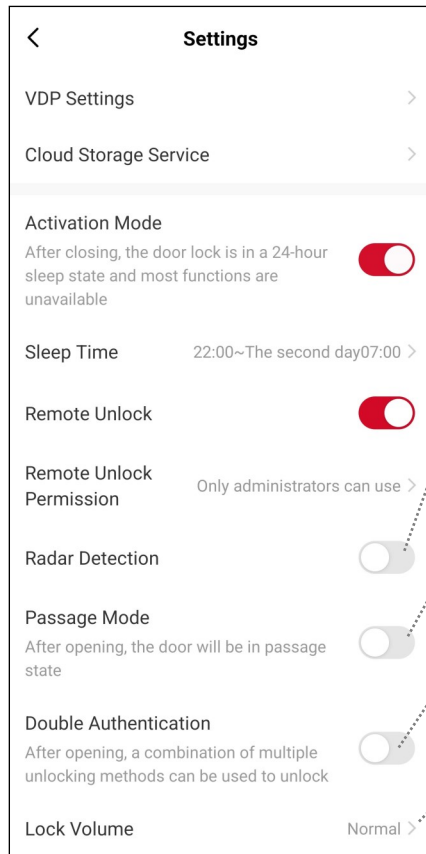

#### 5. Radar Detection

By default it is disabled. If you prefer automatic person detection for face or palm recognition, enable this option. Note: The range of the sensor is 1.5m, accidental wake-up from passing persons will reduce the battery life.

#### 6. Passage Mode

If enabled the lock will remain unlocked, any person can enter the door.

#### 7. Double Authentication

Also called high security mode. To unlock a person needs to enter any 2 access credentials, for example Face ID + password.

#### 8. Lock Volume

Adjust the lock volume mute to high.

## 4. Lock operation

### 4.9 How to use the Smartphone APP

#### 3. Locally added users

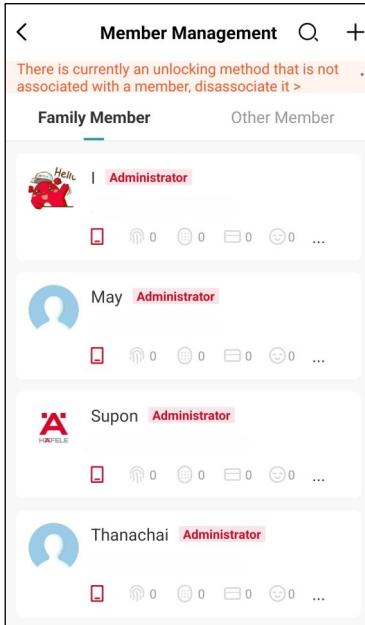

**Local Users from the lock's memory**  
 This message appears, for users added via the locks local menu (not the APP). Click this message to see the screen on the right to assign them to APP Users.

- a.) Local administrators also show up here. They are always the first 3 users:
- Password1
  - Finger2
  - Card3

b.) Locally added normal users will start from Nr. 4, for example: Face4, Finger5, etc.

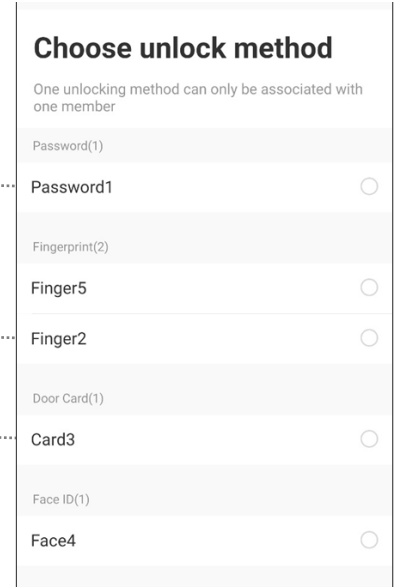

#### 4. Member management

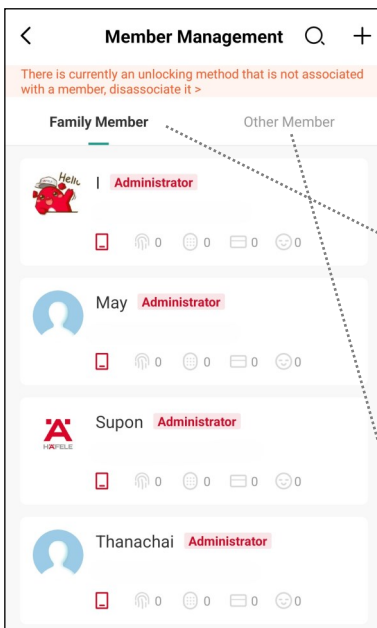

**Member Management**  
 Here you can add/remove and manage all user access credentials for your lock. Select to see the screen on the right

**a.) Family Member**  
 These are the APP users you share your "Home" and all smart home devices, that includes this lock. Users need to sign-up with an APP account to be added. To set permissions or remove, use "Home Management" of the main APP.

**b.) Other Member**  
 Users without APP login can be added and removed here.

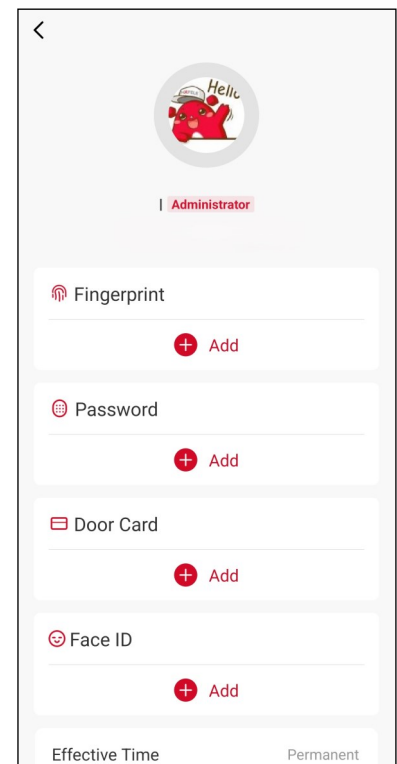

## 4. Lock operation

### 4.9 How to use the Smartphone APP

#### 5. Temporary passcodes

#### 1. Custom passcode (online)

- You can define the passcode digits and set a name for the code by yourself.
- The lock must be active and connected to the APP in order to transfer this code to the locks memory.
- You can check if the code has been successfully transferred by clicking "Record"

#### 2. Time-Limited, One-Time, Dynamic passcodes (offline)

These codes can be created offline and the system automatically assign the digits. The lock will recognize their validity with and an algorithm.

#### 3. Clearing code (offline)

Since the codes in Nr. 2 are not actually in the locks memory, they can only be de-activated by entering a clearing code on the lock itself.

**Table comparison of passcodes**

Type	Must connect to App	How to activate the Code	How to Delete the Code before it expires
Custom	Yes	Unnecessary	After the App connects to the door lock,delete it through the App
Time-Limited	No	The code Activated after use it at least once within 24 hours of the validity period	Use the Clearing Code to delete it
One-Time	No	It can be used only once within 6 hours after creation	Invalid after one use
Dynamic	No	Unnecessary	Expires automatically unavailable
Clearing	No	Use once within 24 hours after creation	Invalid after one use

## 4. Lock operation

### 4.10 Li-ion Battery System

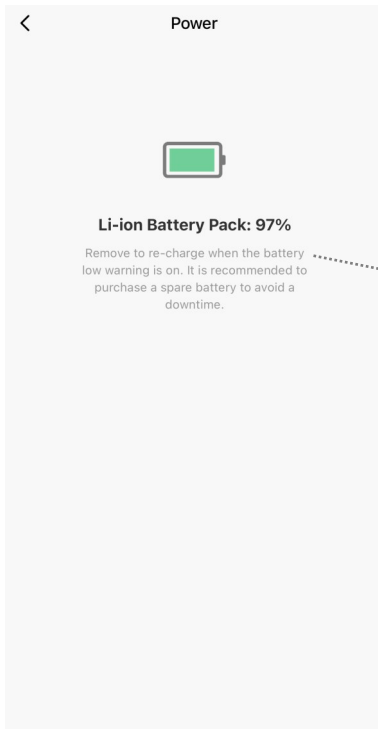

#### **Battery System**

Your lock is equipped with removable Li-ion battery.

#### **Li-ion Battery Pack**

This is the removable and re-chargeable battery pack.

#### **Low battery alarm is ON if:**

The battery pack has less than 20% charge

## 4. Lock operation

### 4.11 Digital door viewer

#### Screen module

The lock features a digital door viewer on the indoor unit with the following key features:

- Camera view from the outdoor unit
- Capture photos (optional microSD card required)
- Record video clips (optional microSD card required)
- Door viewer menu for playback and settings

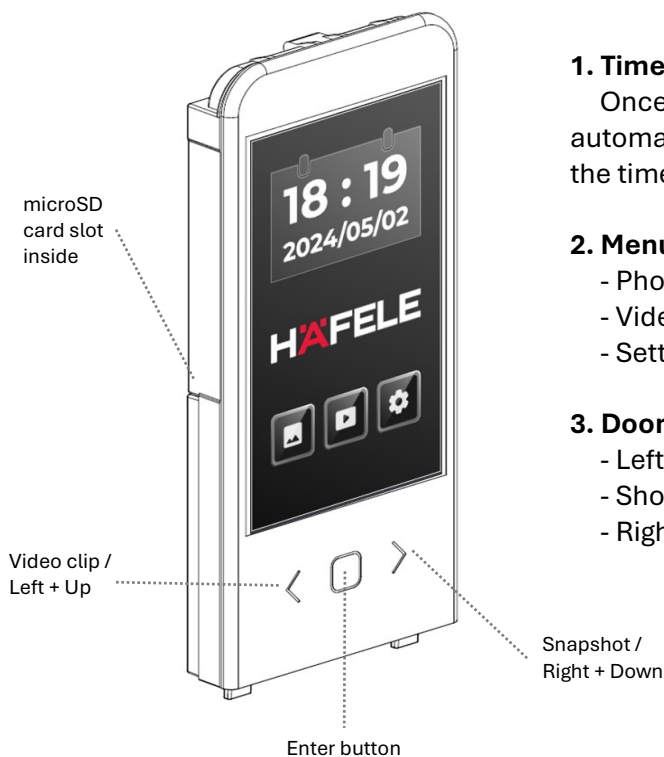

#### 1. Time / Date

Once connected to a Wi-Fi with internet, it will automatically update. (For offline use, you can update the time & date in the menu.)

#### 2. Menu Icons (no touchscreen)

- Photo Viewer
- Video Player
- Settings

#### 3. Door Viewer Menu navigation buttons

- Left + Up
- Short press: Enter / Long press: Back
- Right + Down

**i** Note: To enable Snapshot and Video clip features a microSD with max. 32GB must be installed and formatted inside the screen module (optional, not included with lock).

Max. **32GB**

## 4. Lock operation

### 4.11 Digital door viewer

#### How to use the Door Viewer

##### 1. Activate the screen by pressing the "Enter button"

The camera view will display and you have the following options:

- Press **left side button** to take a "Video clip"
- Press **right side button** to take "Snapshot"

##### 2. Enter the menu by long pressing the "Enter button" while the screen is on.

##### 3. Select options with "Left/Right" buttons highlighting one of the menu points:

###### a.) Photo Viewer

- Browse photos with "Left/Right" buttons.
- Return to camera view by long press "Enter button" and select "Switch back to camera view".

###### b.) Video player

- Browse videos with "Left/Right" buttons. Play the video by short press "Enter button".
- Return to camera view by long press "Enter button" and select "Switch back to camera view".

###### c.) Settings Menu

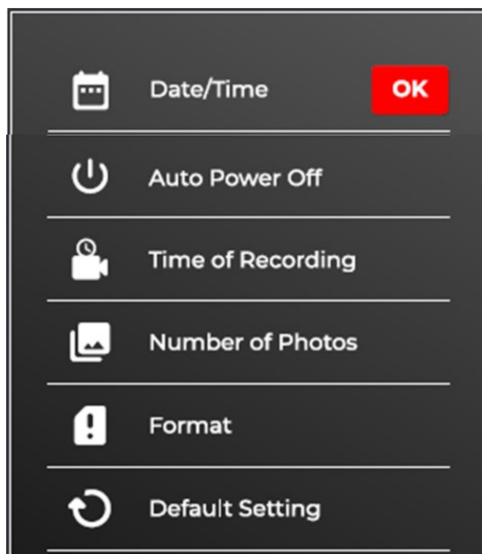

Use the "Left/Right" buttons to move the  symbol to select a menu point:

- **Short press** the "Enter button" to select.
- **Long press** the "Enter button" to return to the previous menu.

##### 1. Date/Time

Manually set lock date and time.

##### 2. Auto Power Off

Adjust the screen off time from 10, 20 or 30 seconds.

##### 3. Time of Recording

Adjust the video recording time from 5, 10 or 15 seconds.

##### 4. Number of Photos

Adjust number of pictures taken when you snapshot button from 1 to 3.

##### 5. Format

When inserting a new microSD card, it must be formatted here to work properly.

##### 6. Default Setting

Reset all menu settings to defaults (no data is deleted).

## 5. Service features

### 5.1 Emergency power supply

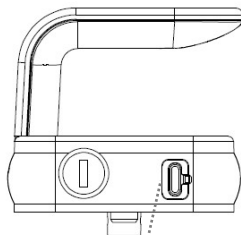

USB Type-C power port

#### Emergency power

If the batteries are completely empty and the lock is without power, perform these steps to recover normal operation:

1. Connect a 5V power supply to the USB-C port at outdoor unit, wait 10s for the lock to startup and unlock the door.
2. Remove the Li-ion battery pack and charge it full (a full charge takes 5-6 hours).

### 5.2 Battery removal

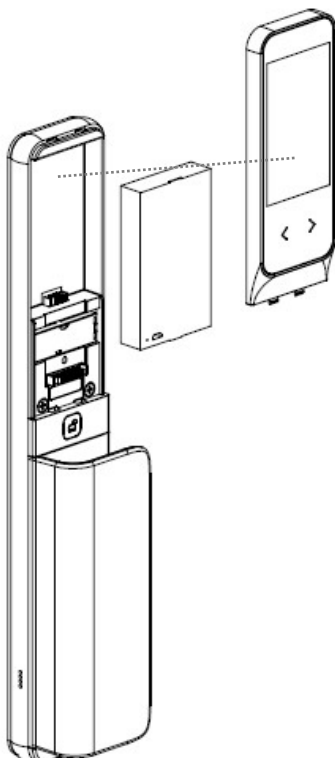

#### Battery removal

1. Hold the screen module with your hand and carefully slide it upwards. Remove the battery pack.
2. Insert a charged battery pack and reinstall the screen module by attaching it first and then slide it downwards into place.

## 5. Service features

### 5.3 Restore factory settings

 **Caution:** This action will delete all data, APP and accessories pairing information, settings and all user data!

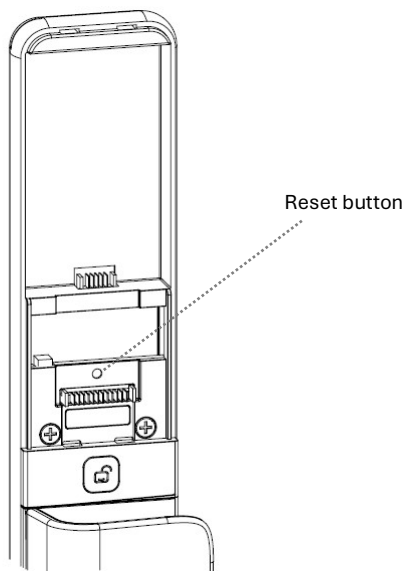

#### Restore factory settings

1. Locate the "Reset" button under the screen module of the indoor unit.
2. Gently press the reset button with a paper clip or similar until you hear 5 short beeps and a voice prompt "Please wait".
3. The lock will now reboot and confirm with a voice prompt "Initialization Successful".

### 5.4 Troubleshooting guide

Problem description	Possible solution	Reference page

